

# Understanding FTIR formaldehyde measurement and its influence on the RICE NESHAP rule

Authors: Shazam Williams-R&D Manager, Yuki Leung-Research Engineer, Joe Aleixo-Technical Services Manager, Robin Hu-Catalyst Scientist

Company: DCL International Inc., P.O. Box 90, Concord, Ontario, Canada, L4K 1B2

## Abstract

This paper discusses the issues of measuring formaldehyde on rich burn natural gas engines typically used in the gas compression industry in the United States. Recently, the EPA passed the final rule for reciprocating internal combustion engines to meet the national emission standards for hazardous air pollutants (i.e. RICE NESHAP rule) for both compression ignition (CI) and spark ignited (SI) engines. In natural gas lean burn engines, carbon monoxide (CO) is measured and used as a surrogate for formaldehyde and other hazardous air pollutants (HAPs). In rich burn natural gas engines, formaldehyde is directly measured in the field and used as a surrogate to represent the various HAPs present in engine exhaust. The recommended methods for the measurement of formaldehyde are EPA method 320 or ASTM D6348-03. For both of these methods, a Fourier Transform Infrared (FTIR) spectrometer is required. The FTIR is a very sophisticated instrument that is capable of measuring very low concentrations of formaldehyde. Similar to other analytical instruments, the instrument must be correctly setup to give realistic, unbiased readings. This is particularly true at low concentrations such as the levels specified in the RICE NESHAP rule. For rich burn engines greater than 500 horsepower, the rule requirement is greater than 76% formaldehyde removal efficiency or below 2.7ppmv@15% O<sub>2</sub>.

This paper will discuss how FTIR formaldehyde measurement is influenced by instrument setup and the presence of other exhaust chemical components. A model gas reactor is used to simulate major exhaust gas components, giving a stable, known gas stream input to the FTIR. Step changes in the individual gas components were made and the effect on formaldehyde measurement was determined. It was determined that special care needs to be taken to avoid hydrocarbon bias in the formaldehyde measurement at a FTIR gas cell temperature of 150°C.

**Table of Contents**

1 Introduction ..... 4

    1.1 Rice NESHAP rule ..... 4

    1.2 FTIR operation..... 4

    1.3 Potential problems..... 5

        1.3.1 Identification and quantification..... 5

        1.3.2 Interferences..... 6

        1.3.3 Formaldehyde analysis – Low concentration..... 6

    1.4 Objective/Goal ..... 6

2 Experimental/Test Description..... 6

    2.1 Test parameters ..... 6

        2.1.1 Instrument setup – Gas calibrations..... 6

        2.1.2 Exhaust chemical components..... 7

    2.2 Description of equipment..... 7

    2.3 Calibration ..... 9

3 Results and discussion ..... 9

    3.1 Model gas reactor (MGR) - controlled condition testing ..... 9

        3.1.1 Baseline..... 9

        3.1.2 Step change experiments ..... 10

4 Implications of results on field testing..... 17

    4.1 Field testing examples..... 17

    4.2 Accuracy in field test numbers ..... 19

    4.3 Conclusion for field testing..... 19

    4.4 Recommendation on optimization of FTIR sampling in field tests ..... 19

5 Conclusion..... 19

6 Acknowledgement..... 20

Appendix A – FTIR gas analyzer qualification..... 21

    A.1 Signal level and detector linearity ..... 21

    A.2 Signal to noise ..... 21

    A.3 Instrument line shape and laser frequency ..... 22

A.4 Check the raw detector signal level (preamp) .....	23
--	----

**List of tables and figures**

Figure 1: Process flow diagram of model gas reactor tests. ....	8
Figure 2: Example of step change experiment.....	9
Figure 3: Formaldehyde bias in step test with methane, comparison of results between 150°C and 191°C method. ....	10
Figure 4: Formaldehyde bias in step test with ethane, comparison of results between 150°C and 191°C method. ....	11
Figure 5: Formaldehyde bias in step test with hydrocarbon mixtures, comparison of results between 150°C and 191°C method. ....	12
Figure 6: Formaldehyde bias in step test with ethane with 6ppm formaldehyde in stream, comparison of results between 150°C and 191°C method. ....	13
Figure 7: Methane and propane biases by ethane using 150°C method. ....	13
Figure 8: Ethane calibration report, original single point 150°C calibration. ....	14
Figure 9: Ethane calibration report, multiple points 150°C calibration provided by MKS. ....	15
Figure 10: Formaldehyde bias in step test with ethane at 150°C cell temperature, comparison of results between single point and multiple points ethane calibrations. ....	16
Figure 11: Methane and propane biases in step test with ethane at 150°C cell temperature, comparison of results between single point and multiple points ethane calibrations. ....	16
Figure 12: Schematic diagram of field test setup.....	17
Table 1: Formaldehyde readings of engine emission tests result @ 5% O <sub>2</sub> . ....	17
Table 2: Ethane readings of engine emission tests result @ 5% O <sub>2</sub> . ....	18
Table 3: Comparison of CH <sub>2</sub> O conversion of with and without bias adjustment for engine 1 example. ....	18

# 1 Introduction

## 1.1 Rice NESHAP rule

In 2010, the EPA finalized a national regulation for reducing emissions from stationary compression ignition (CI) and spark ignition (SI) engines. This rule is commonly called RICE NESHAP (Reciprocating Internal Combustion Engines National Emission Standards for Hazardous Air Pollutants). The compliance deadlines for the rule are in 2013.

The rule is intended to reduce emissions of hazardous air pollutants (HAPs) that are hydrocarbon derivatives from fuel and lube oil combustion. For internal combustion engines these HAPs include formaldehyde, acetaldehyde, acrolein, methanol, benzene, toluene, 1,3-butadiene, 2,2,4-trimethylpentane, hexane, xylene, naphthalene, PAH, methylene chloride, and ethylbenzene.

The rule requires a number of maintenance practices to be followed, and requires emission control catalysts in certain instances, depending on the engine's power rating, hours of operation, whether the site is a major source or area source, etc.. In the case of CI and lean burn SI engines, carbon monoxide (CO) is used as the measurement surrogate for HAPs. Carbon monoxide is assumed to correlate to HAPs levels, and CO can be measured in a repeatable manner in the field with portable equipment at a low cost. In the case of non-emergency rich burn SI engines, over 100 hp in major sources and over 500 hp in area sources, the RICE NESHAP rule requires that formaldehyde be directly measured and that it be used as the representative for all HAPs.

The formaldehyde measurement methodologies are unfamiliar to many operators of stationary internal combustion engines. As the prescribed measurement standards, EPA proposed using EPA Method 320 or ASTM D6348-03 which both use Fourier Transform Infrared (FTIR). EPA also proposed EPA Method 323 as an alternative, which is a colorimetric measurement based on a chilled impingement train method. Due to relatively low concentrations of formaldehyde in the exhaust stream, and the complexity of the measurement equipment, accurately determining formaldehyde in a plant setting in a consistent manner presents a number of challenges. FTIR is expected to be the primary type of instrument for field measurement of formaldehyde from stationary internal combustion engines. As such, in order to assist and educate those involved with implementing the RICE NESHAP rule, this paper will describe issues and challenges of using FTIR for formaldehyde measurement.

## 1.2 FTIR operation

Formaldehyde (HCHO or CH<sub>2</sub>O) is the most abundant gas phase carbonyl compound (10-100 ppb in polluted urban air) in the ambient atmosphere, originating from both emissions in combustion sources and from atmospheric oxidation of methane, as well as non-methane hydrocarbons (NMHCs). Formaldehyde is classified in Group 1 (human carcinogen) by the International Agency for Research on Cancer due to its carcinogenicity [1]. Because of the important role CH<sub>2</sub>O plays from an atmospheric chemistry and a toxicology viewpoint, a variety of methods have been developed for the determination

of CH<sub>2</sub>O [2]. Spectroscopic methods, particularly Fourier Transform InfraRed (FTIR) absorption, are commonly used to provide real-time measurement of formaldehyde. These FTIR monitoring techniques are also specific, non-destructive and quantitative due to the intrinsic sensitivity of vibrational spectroscopy to molecule structures.

A FTIR spectrometer can be used to detect the presence of different species such as CO, CO<sub>2</sub>, NO, hydrocarbons, and any other infrared active molecules simultaneously while some other procedures rely upon the use of an array of different analytical instruments each one dedicated to the detection of one species. This presents a considerable advantage to nonintrusive FTIR spectroscopy compared with conventional methods.

The FTIR requires long optical paths or use multiple-pass cells to attain adequate sensitivity in order to detect formaldehyde or other compounds with low concentrations. The requirement of large, complex and expensive instrumentation makes these methods not amenable for routine applications in the past. In the case of FTIR spectroscopy, an infrared beam is passed through a sample cell of up to two kilometers in a multiple-reflection optical path. Formaldehyde could be detected by a characteristic doublet at 2779 and 2781.5 cm<sup>-1</sup> with a reported detection limit of approximately four ppb [2].

In our tests, sample gas was measured using a Fourier Transformed Infrared Spectrometer manufactured by MKS Instruments (Multi-gas analyzer, model 2030HS). According to the manufacturer specification, MKS 2030HS multi-gas analyzer is capable of ppb to % sensitivity [3]. It can simultaneously analyze and display more than 30 gases; and perform analysis in gas streams containing up to 30% water [3].

Sample gas is fed to the FTIR gas analyzer continuously during tests. Different wavelengths of the infrared beam are passed through the sample, and partially absorbed by the gas species. The FTIR gas analyzer measures absorption spectrum which is unique for each infrared-active gas. Data are then processed by its software package (MG2000 Multigas) to calculate the concentration of each gas using pre-loaded calibrations which have been validated against the on-line EPA library or against NIST traceable gas mixture.

### 1.3 Potential problems

However, there are a number of disadvantages or limitations of using FTIR spectrometers to measure formaldehyde and other molecules in the engine exhaust emissions. Restrictions are imposed by calibration files, spectrum interferences, high water content up to 20%, and the requirement for expensive and elaborate instrumentation [4].

#### 1.3.1 Identification and quantification

Identification and quantification of all the species present in engine exhaust is impossible. The compounds of diesel and natural gas are extremely complex [5,6,7]. The organic compounds in engine exhaust can be classified by the following categories: Non-Methane Hydrocarbons (NMHC), Carbonyl compounds, polycyclic aromatic hydrocarbons (PAH) – including nitro-PAHs (n-PAH) – and polychlorodibenzo dioxins and furans. Among these compounds, there are at least 92 kinds of hydrocarbons identified in the NMHC category [5]. In spectral regions where different compounds have

overlapping features, it can be very difficult to distinguish between them and to assign spectral lines to specific compounds.

### **1.3.2 Interferences**

Interferences can be divided into the following two major categories:

#### **1.3.2.1 Analytical interferences**

Analytical interference is also called the background or spectral interference. It occurs when two or more compounds have overlapping absorbance bands in their infrared spectra. To minimize analytical interferences, a new background must be collected periodically, but no other corrective action will be required [8] because these interferences have been carefully taken into account by the pre-loaded calibration files that comes with the FTIR instrument. For instance, spectral interferants were carefully identified and “picket fenced”. “Picket fencing” means some spectra regions from the analysis region are removed in order to avoid interferences with other gases or remove noisy valleys [9]. This allows the analysis algorithm to weight out unwanted portions of the analysis region [9].

#### **1.3.2.2 Sampling system interferences**

These are the interferences that prohibit or prevent delivery of the target analytes to the FTIR gas cell. Examples of potential sampling system interferences are unwanted moisture condensation within the sampling system, heavy deposition of particulate matter or aerosols within the sampling system components, or reactive gases [10]. The analyte spike procedure in EPA method 320 is designed to measure sampling system interference, if any [8].

### **1.3.3 Formaldehyde analysis – Low concentration**

According to MKS, formaldehyde detection limit (and error bar) is approximately 0.3 ppm without a custom water calibration. Formaldehyde is tricky to calibrate because it tends to polymerize against the cylinder walls of the gas container. As a result, low concentration readings might not be reliable. The detection limit of formaldehyde can be less than 0.1 ppm with a custom water calibration. [12]

## **1.4 Objective/Goal**

For rich burn engines greater than 500 horsepower, the RICE NESHAP rule requirement is greater than 76% formaldehyde removal efficiency or below 2.7ppmv@15% O<sub>2</sub>. Given that the FTIR measurement of low formaldehyde concentration is difficult, the main goal of this paper is to investigate how accurate low formaldehyde measurement is, with different instrument settings and the presence of other exhaust chemical components.

## **2 Experimental/Test Description**

### **2.1 Test parameters**

#### **2.1.1 Instrument setup – Gas calibrations**

Before taking measurements on the FTIR, the user needs to select a desired method for the test. Each ‘method’ is a file location where required calibration files from multiple locations are copied into [9].

They are pre-loaded by the FTIR manufacturer, MKS, for use in their MultiGas software. Each method consists of specific calibration files which are collected with particular instrument settings, including the FTIR spectral resolution and line position, gas cell path length, temperature and pressure, and the apodization function [10]. Instrument settings in field tests must be the same as in the chosen method used to quantify the gas concentration(s), or else appropriate corrections must be made [10]. Users can create their own gas calibrations if needed, but note that it is an advanced operation.

In this paper, the importance in the choice of FTIR methods will be investigated. The focus will be on different gas cell temperatures. Experiments were performed with the following methods and compared for the accuracy in formaldehyde readings [12]:

1. Method at 191°C gas cell temperature:
  - It is the recommended method by the MKS. It has a narrower wavenumber range and has "picket fenced" against interfering species, which makes it less sensitive to biases.
  - The disadvantage is that readings are less sensitive (high detection limit) because fewer signals are used.
2. Method at 150°C gas cell temperature:
  - It is an older method which was not tuned as thoroughly as the one at 191°C. The formaldehyde calibration in this method uses a different wavenumber range than the 191°C method, and is less "picket fenced" against other components.
  - It contains more components than in the 191°C method, therefore a higher chance that components might interfere with one another.

### **2.1.2 Exhaust chemical components**

Methane and ethane in the exhaust gas are the possible analytical interferences of formaldehyde. In this paper, the influence of formaldehyde measurement by the presence of these three components will be studied by step change tests (described below).

## **2.2 Description of equipment**

Exhaust gas conditions were simulated using DCL's model gas reactor: Omega FMA series mass flow controllers were used to control stable, known gas stream inputs from certified gas cylinders to the sampling system. Gases were mixed as a bulk stream and were preheated to higher than 100°C by a preheater. All the sampling lines were heated by heating tape to prevent water condensation. The heated gas stream was then fed to the MKS 2030HS FTIR analyzer. A gas cell with 5.11 meter path length was used and the FTIR was maintained at one atm pressure. Excess flow was vented. It is noted that the gas cylinders used in the experiments were checked for the presence of formaldehyde in the cylinders prior to tests.

The following is the process flow diagram of our model gas reactor:

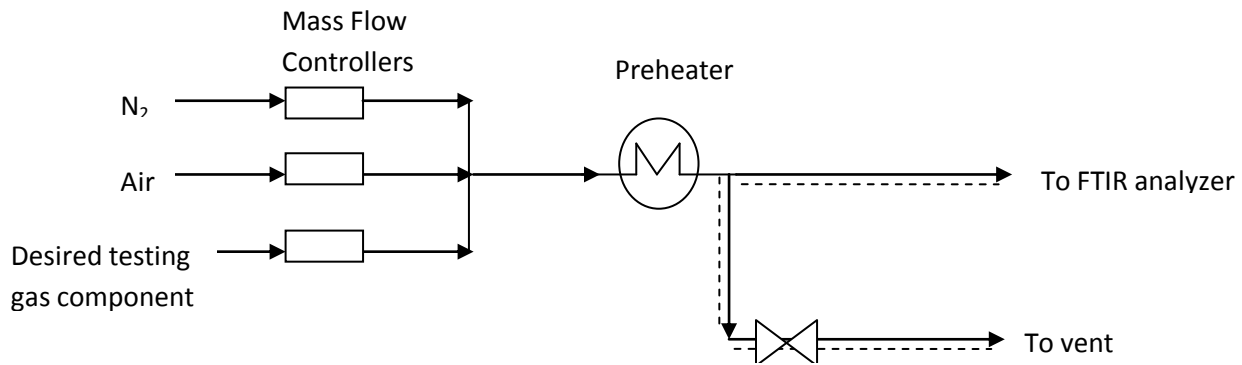

Figure 1: Process flow diagram of model gas reactor tests.

FTIR instrument qualification steps were performed prior to experiments to ensure good instrument performance. Please refer to Appendix A for steps and results.

The main idea of the test is to investigate how FTIR formaldehyde measurement is influenced by instrument settings and the presence of other exhaust chemical components. Step change tests with individual gas components were made and the effect on formaldehyde measurement was determined:

1. The cell of the FTIR was set to the desired testing cell temperature. Corresponding calibration files were chosen.
2. The system was purged with dry nitrogen gas to obtain a zero reference spectrum.
3. Step tests of individual gas component:
  - i. Presence of formaldehyde in the cylinders was checked prior to experiments.
  - ii. A fixed flow rate of air and nitrogen stream was introduced to the FTIR as a base stream with the use of mass flow controllers. The gas stream and the lines were heated.
  - iii. A known concentration and flow rate of the desired testing gas component (e.g. methane) was introduced to the gas stream as a step change.
  - iv. The system was allowed to stabilize until all the readings were steady and FTIR readings were recorded. An average reading for a duration of five minutes was taken.
  - v. Repeat steps iii - iv for a few concentration set points. Figure 2 below shows an example of a step change test. The desired testing component (e.g. methane) was added to the feed stream by incremental increases.
  - vi. Repeat tests with different instrument settings (i.e. 150°C method and 191°C method).



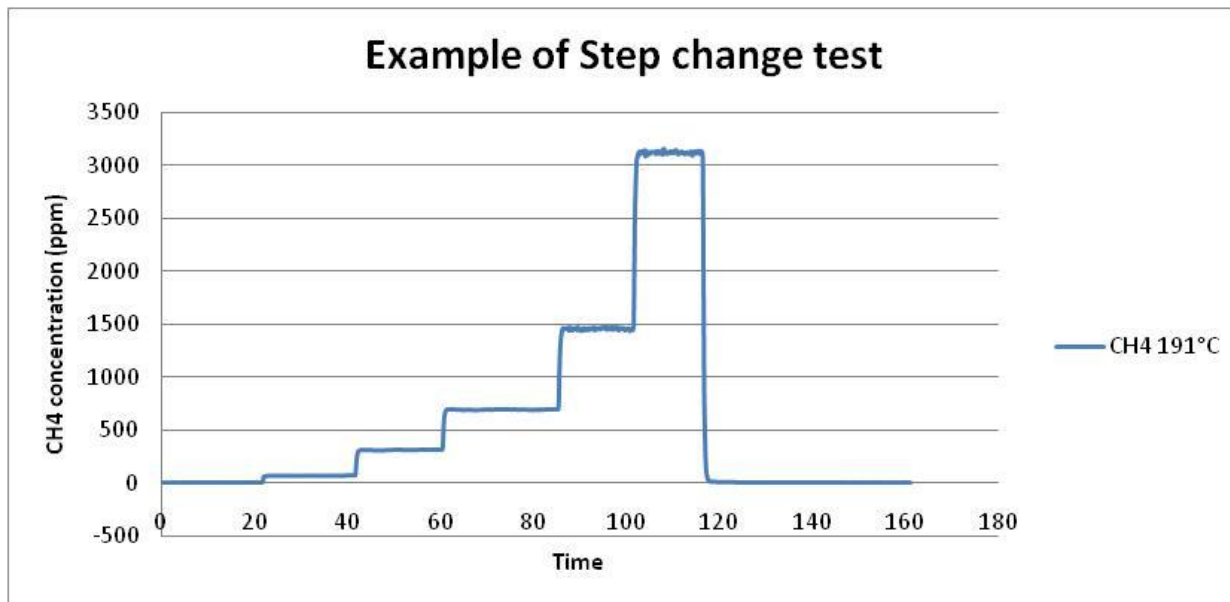

Figure 2: Example of step change experiment

## 2.3 Calibration

The formaldehyde mass balance was validated before experiments. The procedure was as followed: 10  $\mu\text{L}$  of certified 37% w/w formaldehyde solution, supplied by Fisher Scientific, was injected to the closed FTIR system with nitrogen-gas-only stream. Injection was made as close to the FTIR as possible to reduce any adsorption of formaldehyde onto the tubing walls. The tubing to the FTIR was heated to 100°C. The input and output mass was calculated and found to be balanced, with an error less than 5%. According to ASTM D6348-03, an accuracy of +/- 20% and a precision of +/- 10% for each measurement value should be possible when procedures detailed in the standard are followed. In practice (field tests), an accuracy of 10% and precision of 5% are routinely achieved. The error was less than five percent for both 150°C and 191°C gas cell temperature methods. Errors were acceptable within the FTIR noise, human error of injection, error of the syringe, etc. [10]

## 3 Results and discussion

### 3.1 Model gas reactor (MGR) - controlled condition testing

#### 3.1.1 Baseline

A background spectrum was collected by directing dry nitrogen from liquid nitrogen tank through the entire sampling system to set a zero reference (baseline) for all the tests. The same gas cell conditions (i.e. temperature, pressure, and pathlength) were used for sample analysis.

### 3.1.2 Step change experiments

#### 3.1.2.1 Methane

##### 3.1.2.1.1 Step test with methane

A fixed flow rate of air and nitrogen was fed to the FTIR as a base stream, and different concentrations of methane gas were added as step changes (see Figure 2). No input of formaldehyde was included in the stream.

It was observed in Figure 3 that formaldehyde reading was within the FTIR detection limit of 0.3ppm and the standard deviations during the experiment. It shows that methane does not cause bias in formaldehyde readings in both the 150°C and 191°C methods. It is noted that 'formaldehyde bias' on the y-axis = formaldehyde reading on the FTIR – actual formaldehyde concentration in the stream (0ppm). This definition of CH<sub>2</sub>O bias will be used throughout the paper.

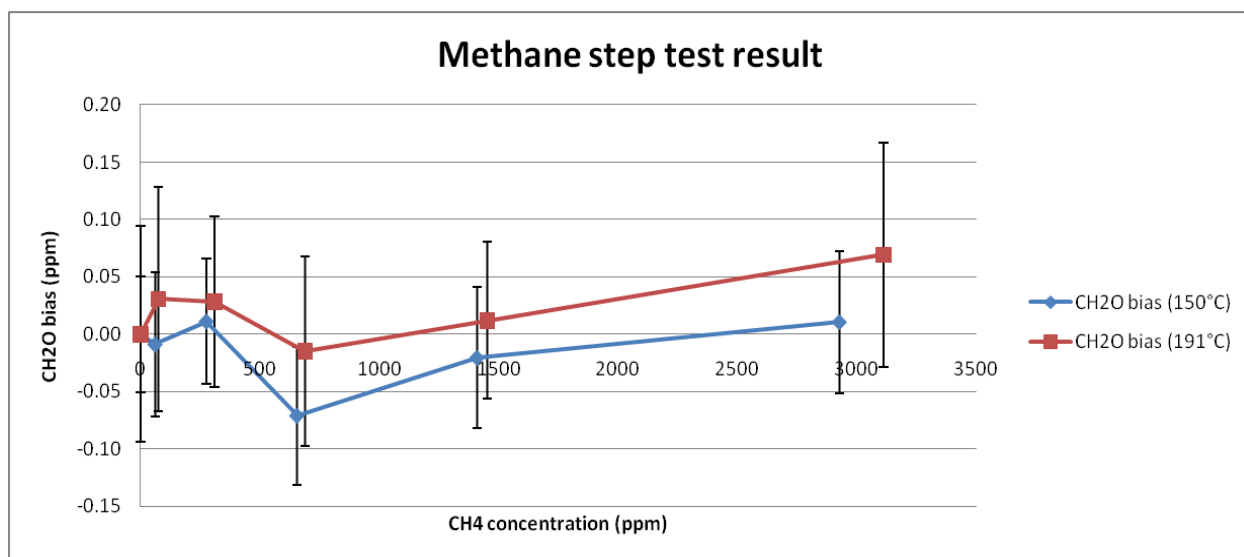

Figure 3: Formaldehyde bias in step test with methane, comparison of results between 150°C and 191°C method.

#### 3.1.2.2 Ethane

##### 3.1.2.2.1 Step test with ethane

A fixed flow rate of air and nitrogen was fed to the FTIR as a base stream, and ethane gas were added as step changes. No input of formaldehyde was included in the stream.

It was observed in Figure 4 that with the 150°C cell temperature method, [CH<sub>2</sub>O bias] = 0.004[C<sub>2</sub>H<sub>6</sub>]. For 191°C cell temperature method, formaldehyde bias is within the FTIR detection limit of 0.3ppm. This shows that with the gas cell temperature of 150°C, a concentration of 400 ppm ethane in the gas feed will give a positive bias of ~1.8 ppm CH<sub>2</sub>O when no CH<sub>2</sub>O is present in the gas stream.

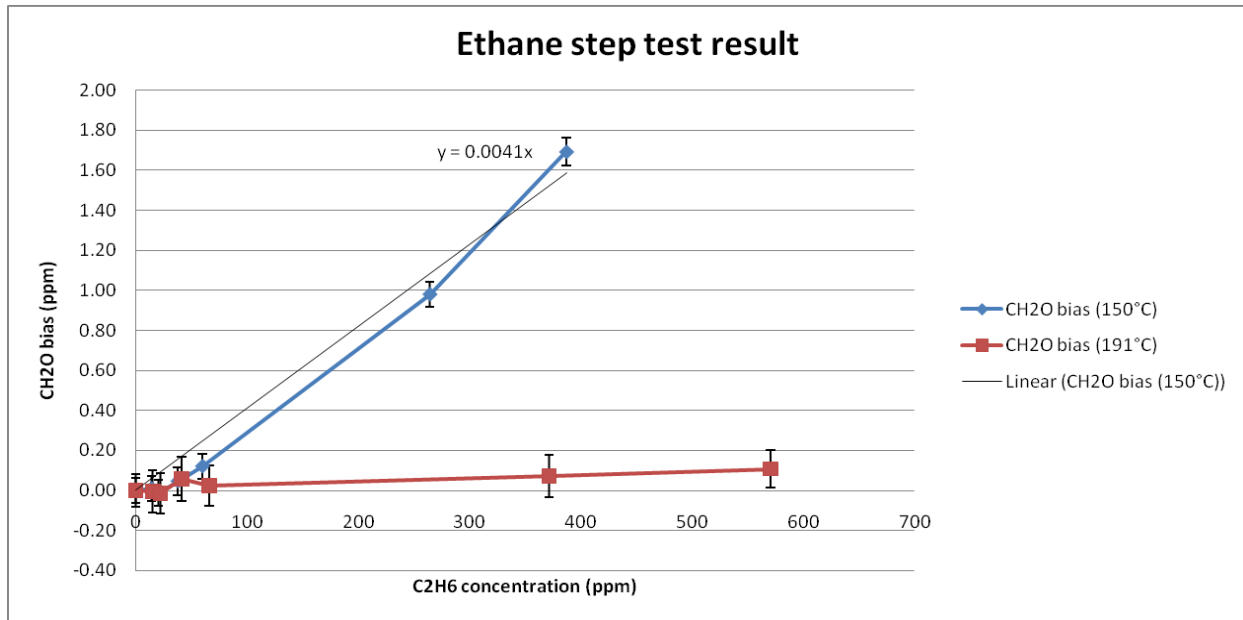

Figure 4: Formaldehyde bias in step test with ethane, comparison of results between 150°C and 191°C method.

### 3.1.2.2.2 Step test with hydrocarbon mixtures

In view of the bias as seen in Section Step test with ethane, tests were redone with hydrocarbon mixtures replacing ethane gas to check if there is any influence with the presence of multiple exhaust components: A fixed flow rate of air and nitrogen was fed to the FTIR as a base stream, and hydrocarbon mixtures were added as step changes. The hydrocarbon mixture contains 40% methane, 6% ethane, and 2% propane. No input of formaldehyde is included.

Result was consistent with the ethane-only test (Section Step test with ethane 3.1.2.2.1) where addition of methane and propane in the stream showed no change in formaldehyde bias with ethane. For instance,  $[\text{CH}_2\text{O bias}] = 0.004 [\text{C}_2\text{H}_6]$  for the 150°C method, and no significant bias when using the 191°C method. (See Figure 5)

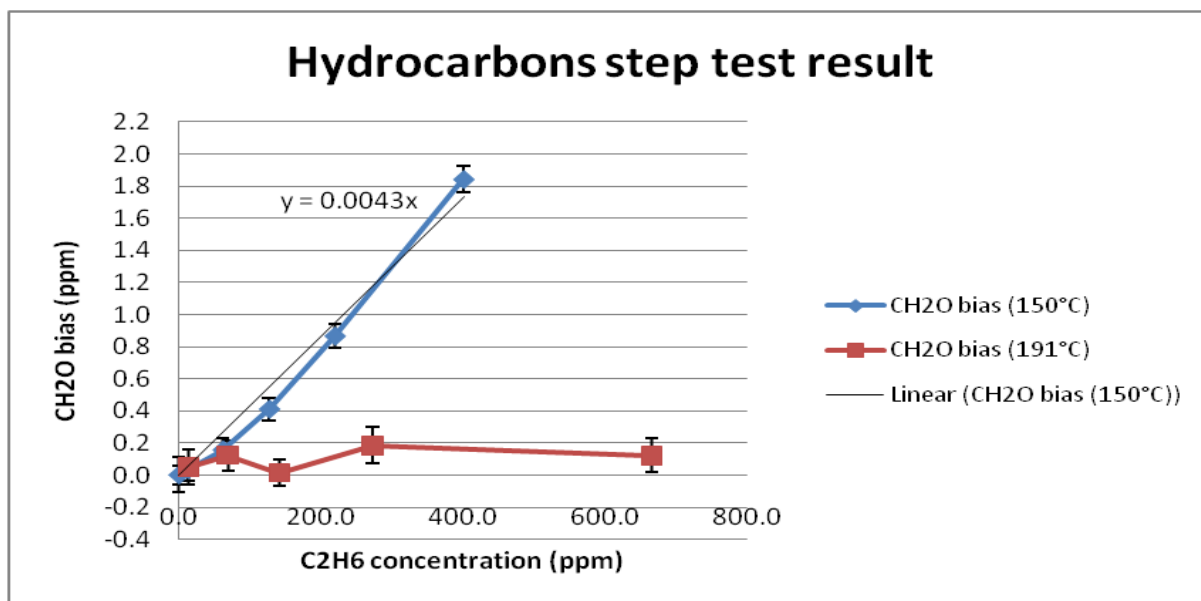

Figure 5: Formaldehyde bias in step test with hydrocarbon mixtures, comparison of results between 150°C and 191°C method.

#### 3.1.2.2.3 Step test with ethane, with the presence of formaldehyde in stream

To better understand if the presence of formaldehyde in the exhaust stream would give greater bias with ethane input, test in section 3.1.2.2.1 was also redone with constant formaldehyde added in the base stream: A fixed flow rate of air and nitrogen was fed to the FTIR as a background stream with approximately 6 ppm formaldehyde. The nitrogen stream was bubbled through a solution containing CH<sub>2</sub>O and water. Upon exiting the solution the gas stream contains approximately 6ppm CH<sub>2</sub>O. Ethane was added to the feed stream by incremental increases. The result was observed to be consistent with the previous results (See Figure 6), where  $[\text{CH}_2\text{O bias}] = 0.004 [\text{C}_2\text{H}_6]$ . It is noted that ‘formaldehyde bias’ on the y-axis = formaldehyde reading on the FTIR – actual concentration of formaldehyde in the stream (6ppm).

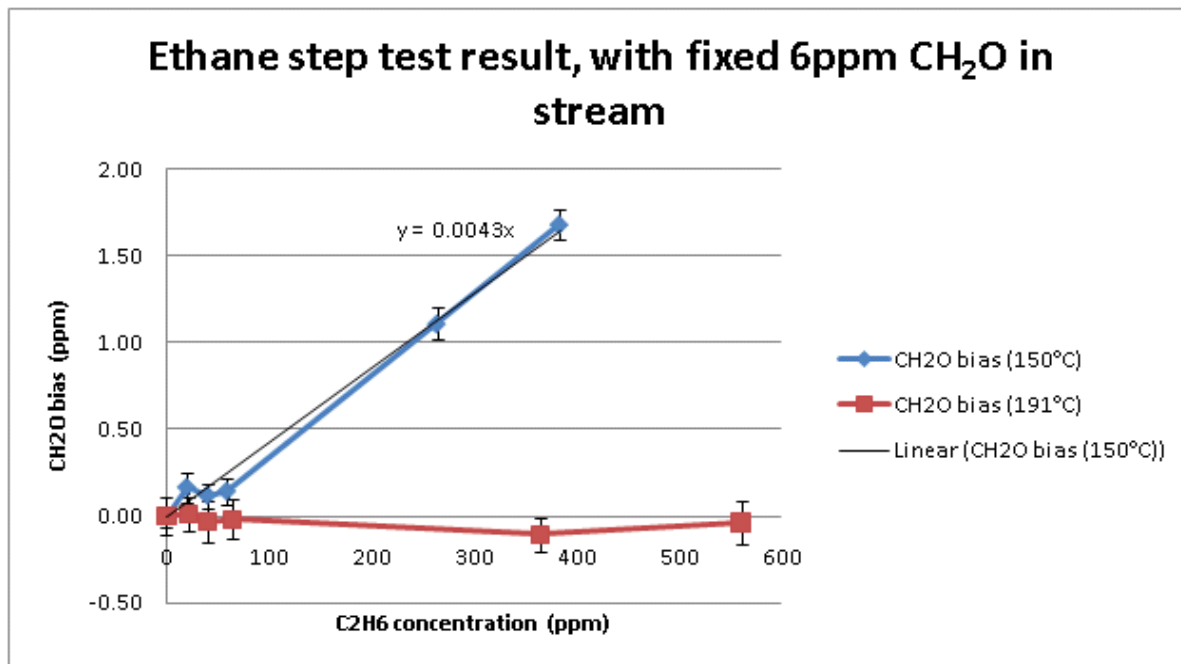

Figure 6: Formaldehyde bias in step test with ethane with 6ppm formaldehyde in stream, comparison of results between 150°C and 191°C method.

### 3.1.2.2.4 Step test with ethane, effects on other hydrocarbons readings

An interesting observation was found during ethane test in section 3.1.2.2.1: methane and propane readings dropped with an increase in ethane using the 150°C method. As showed in Figure 7, propane reading dropped to -30ppm when ethane was close to 400ppm. In this test, a fixed flow rate of air and nitrogen was fed to the FTIR as a base stream, and ethane gas were added as step changes. No input of methane, propane, and formaldehyde were included in the stream.

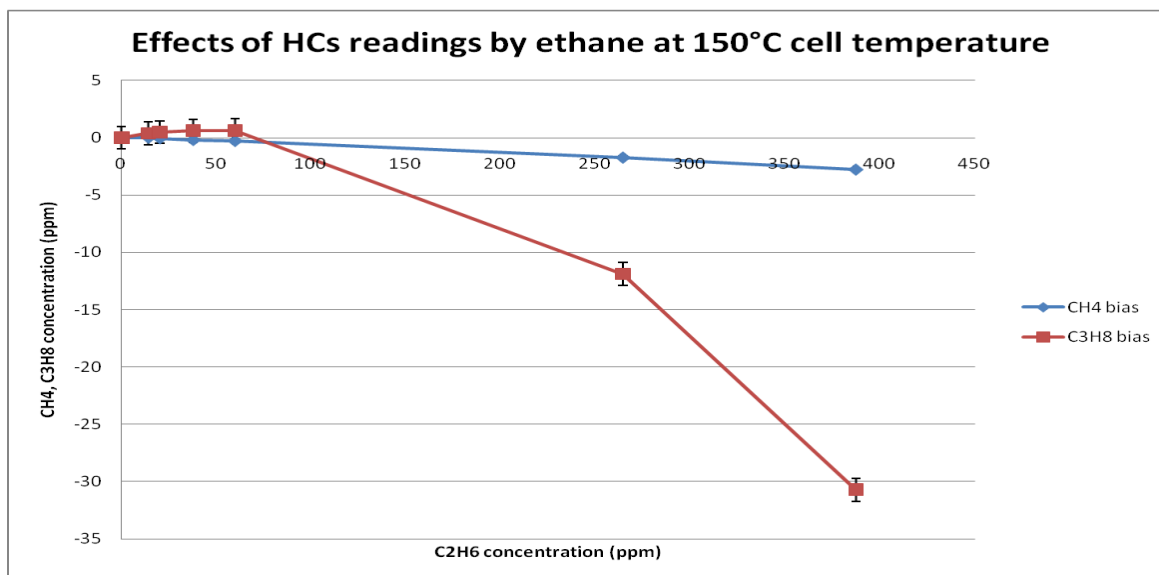

Figure 7: Methane and propane biases by ethane using 150°C method.



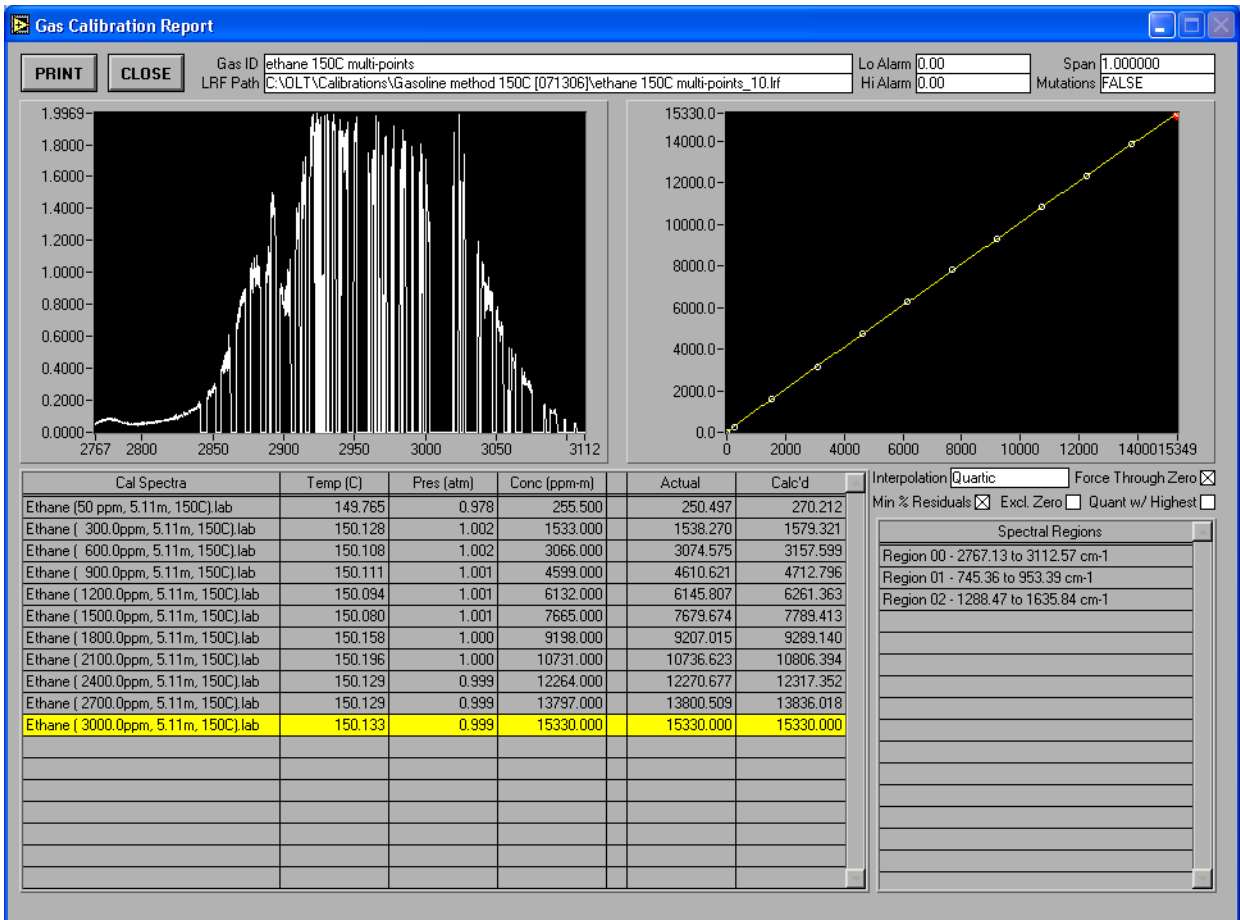

Figure 9: Ethane calibration report, multiple points 150°C calibration provided by MKS.

In our reprocessing, all the calibration files of other gases were kept the same, except the single point ethane calibration was changed to the multiple points calibration. The methane and propane biases in the reprocessed data using the multiple points calibration were also examined. Comparison was made to the results in section 3.1.2.2.1 and 3.1.2.2.4. The formaldehyde bias with ethane step test reprocessed data was found to be less with using the multiple-points ethane calibration (See Figure 10):

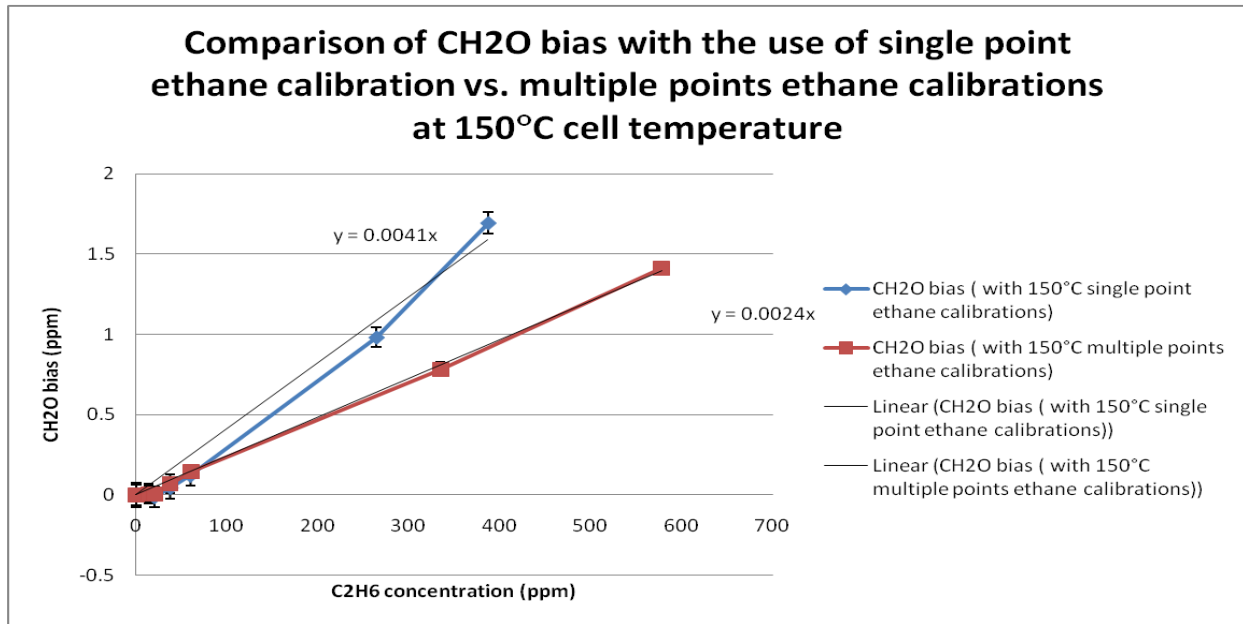

Figure 10: Formaldehyde bias in step test with ethane at 150°C cell temperature, comparison of results between single point and multiple points ethane calibrations.

With the multiple-points ethane calibration files, it can be seen that the methane and propane biases in reading were also greatly reduced (Figure 11):

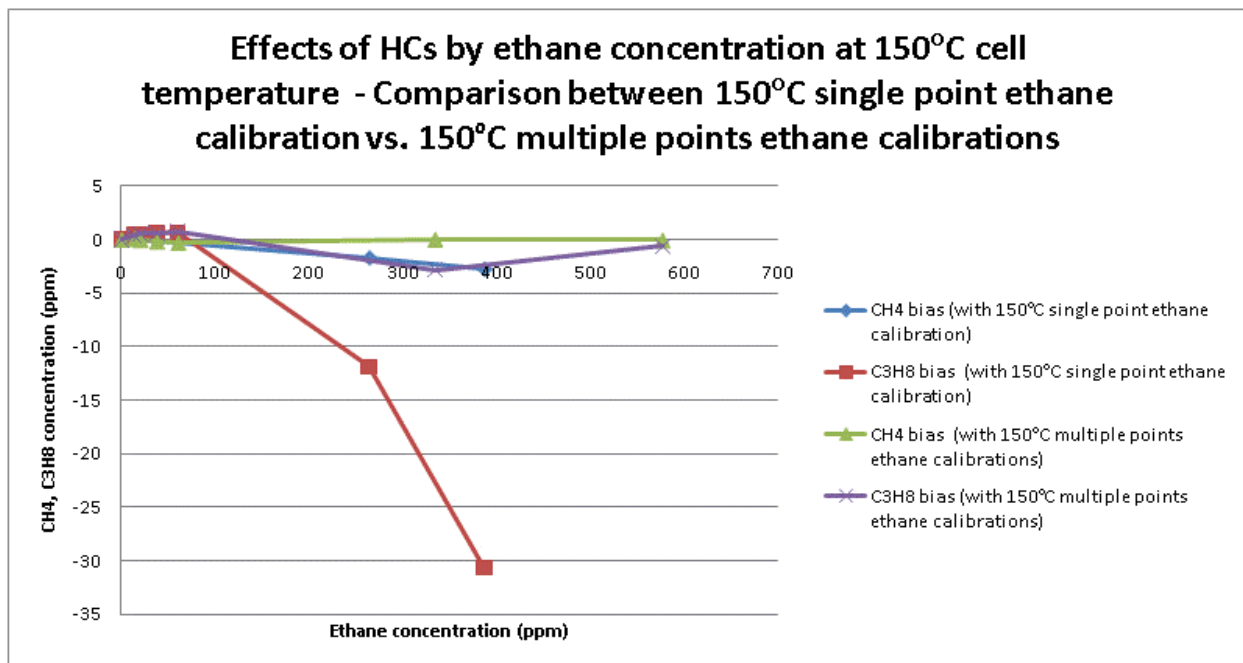

Figure 11: Methane and propane biases in step test with ethane at 150°C cell temperature, comparison of results between single point and multiple points ethane calibrations.

From the above results in this section (Figure 10 and Figure 11), it can be suggested that one of the main reasons of biases in formaldehyde, methane, ethane, and propane readings is the incapability of the



single point calibration file of ethane to match sufficiently well with the spectra of higher concentration of ethane [12].

## 4 Implications of results on field testing

### 4.1 Field testing examples

Below are emissions test data measured from eleven different rich burn-slow speed engines located at different fields. Each engine was equipped with an exhaust after-treatment (three-way) catalyst for emission treatments. Tests were performed with MKS 2030 FTIR analyzer, and with the 150°C cell temperature method used. A gas cell with 5.11 meter path length was used. The FTIR was maintained at one atm pressure. FTIR measured the formaldehyde and ethane concentrations before (= ‘engine outlet’) and after (= ‘catalyst outlet’) the catalyst (See Figure 12). Table 1: Formaldehyde and Table 2 show the test data collected. The data were collected with a 5% O<sub>2</sub> level in engine. It can be seen in Table 1, inlet formaldehyde concentration varies between 4 to 32 ppm with the outlet formaldehyde concentrations varying between 0.4 to 5.3 ppm. Inlet ethane concentrations vary from 0 to 700 ppm whereas the outlet ethane concentrations vary from 0 to 460 ppm.

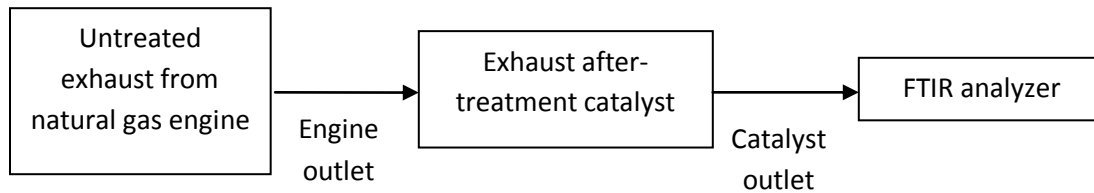

Figure 12: Schematic diagram of field test setup.

Table 1: Formaldehyde readings of engine emission tests result @ 5% O<sub>2</sub>.

Formaldehyde											
Engine #	1	2	3	4	5	6	7	8	9	10	11
Catalyst Outlet (ppm)	5.3	3.71	5.08	1.3	1.91	0.6	0.41	0.4	0.67	0.8	0.5
Engine Outlet (ppm)	19.1	32.0	16.9	5	6.2	4.2	3.7	6.6	5.7	4.3	6.9
% conv.	72.3	88.4	70.0	74.0	69.0	85.7	88.9	93.9	88.1	81.4	92.8

**Table 2: Ethane readings of engine emission tests result @ 5% O<sub>2</sub>.**

Engine #	1	2	3	4	5	6	7	8	9	10	11
Ethane											
Catalyst Outlet (ppm)	459.2	9.6	100	30	0	50.0	0	44.7	0	0	23.3
Engine Outlet (ppm)	703.6	0	0	80	0	140.1	0	70.1	0	48.1	114.9

With the experimental results found in section 4 (i.e. [Formaldehyde bias] = 0.004[ethane]), CH<sub>2</sub>O value could have a bias of as much as 1-2 ppm higher than the real value in usual engine conditions. In this section, we would like to investigate if this bias would affect formaldehyde conversion in the above field tests.

For rich burn engines greater than 500 horsepower, the RICE NESHAP rule requirement is greater than 76% formaldehyde removal efficiency or below 2.7ppmv@15% O<sub>2</sub>. It is noted that a formaldehyde value of less than 9.3ppm CH<sub>2</sub>O for 5% O<sub>2</sub> in the above Table 1 (by correction) is equivalent to 2.7ppm @15% O<sub>2</sub> in the RICE NESHAP rule. It can be observed from the data of engine 4 to 11 that the ‘engine outlet’ CH<sub>2</sub>O levels were low enough to meet the RICE NESHAP rule even without an addition of catalysts. On the other hand, the formaldehyde reduction from engine 1 to 3 passed the rule with the use of a catalyst.

By looking at the data from engine 1, a CH<sub>2</sub>O conversion of 72% was obtained, which is a failure in the RICE NESHAP rule with the criterion of 76% formaldehyde conversion. (Note that the 2.7ppm criterion is omitted for this case of comparison.) However, if the CH<sub>2</sub>O bias of the 150°C method in section 3 ([CH<sub>2</sub>O bias] = 0.004[C<sub>2</sub>H<sub>6</sub>]) is taken into account, the conversion efficiency for engine 1 would be adjusted to 79%, which is a passing conversion for the rule. (See Table 3) This conversion difference can be an issue in emission test especially at low CH<sub>2</sub>O concentrations (less than 10 ppm), or high ethane concentrations situations, which are most likely to occur at low exhaust temperatures or load conditions ( i.e. less than 400°C where minimal conversion of ethane occurs). The effect would be most noticeable when the CH<sub>2</sub>O value is close to the passing target of 76% formaldehyde conversion or 2.7ppmv (@15%O<sub>2</sub>).

**Table 3: Comparison of CH<sub>2</sub>O conversion of with and without bias adjustment for engine 1 example.**

	Ethane	Formaldehyde	Formaldehyde (correct for bias)
Engine outlet (ppm)	703.6	19.1	16.22
Catalyst outlet (ppm)	459.2	5.3	3.42
Conversion %		72.3%	78.9%

It is unclear the reason of the higher 'catalyst outlet' ethane concentrations than 'engine outlet' for engines 2 and 3. One suspicion for the low 'engine outlet' ethane concentration is that air was being pulled into the sampling line and diluting the sample.

## 4.2 Accuracy in field test numbers

One observation from the engine test result was that in some field trials, formaldehyde readings of 'catalyst outlet' showed values of -4 to -5 ppm. (Unfortunately, the hydrocarbon speciation data was not collected for deeper investigation.) These negative numbers indicate that the FTIR analyzer was not zeroed properly, or the 'zero/background gas' contained trace amounts of formaldehyde. Another possibility is that there may be some interferent(s) in the 'zero gas' stream that is not 'picket fenced' by the FTIR software.

In this particular case with improper baseline, the formaldehyde concentrations obtained would give higher values than the real ones (because the reference used is lower than the 'real' zero). The resulting effect would be a lower emission level than what were actually being achieved, and possibly an engine passing the RICE rule that should not.

## 4.3 Conclusion for field testing

The subjects of in-field sampling, error propagation, engine tuning and catalyst function will influence whether a field application will pass the RICE NESHAP rule. These would increase the measurement error and give a wider measurement range. The current RICE NESHAP rule of 76% CH<sub>2</sub>O conversion or 2.7ppm @ 15% O<sub>2</sub> is well suited for FTIR measurement. However, tighter regulations may be difficult to measure in the field.

## 4.4 Recommendation on optimization of FTIR sampling in field tests

To minimise poor measurement especially in the field, it is important to equip the FTIR sampling system with an appropriate sampling setup. First of all, ensure the FTIR sampling probe is heated. A metal or glass stainless steel filter of less than 0.1µm is recommended to place immediately after the heated probe and after the sample condenser system, especially for measuring "sticky compounds", such as HF, HCl, NO<sub>2</sub>, NH<sub>3</sub>. Secondly, the sample line is required to be heated, and to be as short as possible in length. It is important to maintain the gas cell temperature at 191°C, and a pressure of one atm (+/- 5% recommended). Stainless steel lines are preferred over Teflon tubing for most applications. For extractive sampling method, a leak check is crucial if the pump is placed before the FTIR analyzer to prevent any contamination or sample loss; whereas if the pump is located after the FTIR analyzer, special care is needed not to let the pressure go too low. [12]

## 5 Conclusion

The paper shows that the FTIR is very capable of measuring the requirements of the RICE NESHAP rule when the correct method is used. In the case of the MKS 2030, a gas cell temperature of 191°C with the corresponding 191°C calibration method gives optimum results with appropriate sampling. Use of the

150°C calibration method on the MKS FTIR is not recommended due to CH<sub>2</sub>O being positively biased by ethane. Field operators should ensure that the FTIR system is properly zeroed (i.e. no negative bias) and the reading make sense (i.e. inlet values are typically higher than outlet values from a catalyst). For other FTIR systems, the operators should check to ensure no interferences cause unacceptable biases on CH<sub>2</sub>O readings.

## **6 Acknowledgement**

The authors would like to acknowledge the helpful advice and informative discussions with Ms. Sylvie Bosch- Charpenay of MKS instruments Inc. We appreciate the support of DCL International Inc. for this work. Darek Bialasz and Artur Tofilo were extremely helpful in setting up experiments and troubleshooting problems.

## Appendix A – FTIR gas analyzer qualification

FTIR qualification according to MKS manual includes the following tests:

1. Measure instrument signal level and detector linearity
2. Measure signal to noise
3. Measure instrument line shape and laser frequency
4. (additional) Check the raw detector signal level (preamp)

### A.1 Signal level and detector linearity

According to EPA method 320 section 8.3.3, the detector linearity has to be checked by observing the single beam instrument response in a frequency region where the detector response is known to be zero [8]. In that case, according to MKS manual, the response at the region below the detector cut-off is checked to be 0.000 +/- 0.005 within the specification [3]. The specification for the single beam levels and our result are as followed:

Specifications for Single Beam Levels	
Parameter	Specifications
Signal Level at maximum	Within $\pm 20\%$ of recorded value in Datasheet
Wavenumber at maximum signal level	Within $\pm 100 \text{ cm}^{-1}$ of recorded value in Datasheet (may change due to mirror degradation).
Signal level below detector cut-off	0.000 $\pm$ 0.005 (model 2030 only, this parameter is irrelevant for model 2031 and 2032)

<u>Parameter</u>	<u>original datasheet</u>	<u>current values</u>	<u>Pass/fail?</u>
Signal Level at maximum	1.3	1.2	Pass
Wavenumber at maximum signal level	1758.07 $\text{cm}^{-1}$	1750	Pass
Signal level below detector cut-off	/	within 0.000 +/- 0.004	Pass

### A.2 Signal to noise

The signal-to-noise analyzer provides a measure of the sensitivity of the FTIR gas analyzer for the specific spectral resolution and number of scans [9].

According to MKS technical support, use #scan = 10 (scan time of 3.72 sec similar to the original SNR test). The SNR values are checked to be:

<u>Range</u>	<u>Spec from MKS tech</u>	<u>Actual test</u>	<u>Pass/Fail?</u>
--------------	---------------------------	--------------------	-------------------

	<u>support</u>	<u>values</u>	
1000-1100 cm-1	>600	738	Pass
2100-2200 cm-1	>800	1360	Pass
2900-3000 cm-1	>600	747	Pass

### A.3 Instrument line shape and laser frequency

Validate the instrument line shape by inspecting the full width at half height (FWHH) displayed in the Sample Peak Result, and on the graph. The measure and theoretical water lines are displayed on the graph. The two peaks should appear at exactly the same place in the spectrum and should have similar shapes, as in the figure in the manual. [9] The following is the specification of sample peaks result listed in the MKS hardware manual [3]:

Specifications of Sample Peak results	
Parameter	Specifications
Water absorption line	3920.095cm-1 +/- 0.010cm-1
FWHH	(0.25mm detector) <0.50cm-1. optimal below 0.49icm-1
Amplitude	Between 0.15 and 0.25 AU (absorbance units)
Calculated Laser Freq	Within 0.05cm-1 of the original laser freq

[3]

Current values and line shape of our FTIR analyzer is as followed:

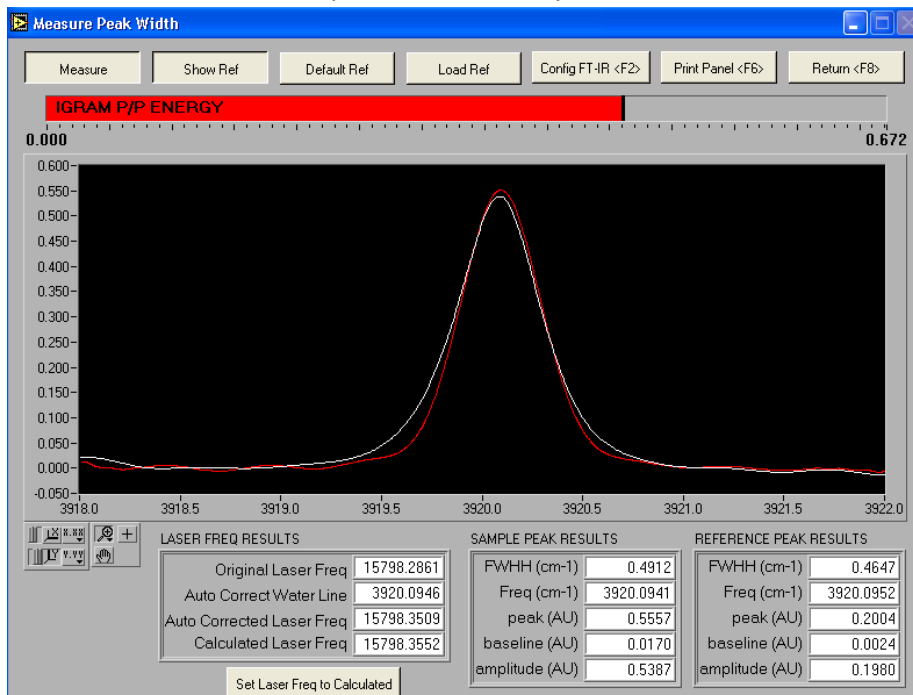

⇒ Pass!

#### A.4 Check the raw detector signal level (preamp)

The preamp level check allows users to verify that the signal from the detector is within specifications. The results for all levels will read "OK" if the signal is between -9.5 volts and 9.5 volts [9]. The preamp result of our FTIR analyzer is acceptable as seen:

	<u>Without N2</u>	<u>1L/min N2</u>	<u>Pass/fail?</u>
Igram Max	4.3	3.75	Pass
Igram Min	-2.16	-2.35	Pass
DC level	2.25	1.79	Pass

## References

- [1] B. Hanoune, T. LeBris, L. Allou, and A. Le Calve, "Formaldehyde Measurements in Libraries: Comparison between Infrared Diode Laser Spectroscopy and a DNPH-derivatization Method," *Atmospheric Environment* 40, 2006.
- [2] A. Vairavamurthy, J. M. Roberts, and L. Newman, "Methods for Determination of Low Molecular Weight Carbonyl Compounds in the Atmosphere -A Review," *Atmospheric Environment* 26A, No.11.
- [3] "MKS Type - MG2000 Hardware Manual," MKS Instruments, Wilmington.
- [4] G. M. Arrigone and M. Hilton, "Theory and Practice in Using Fourier Transform Infrared Spectroscopy to Detect Hydrocarbons in Emissions from Gas Turbine Engines," *Fuel* 84, 2005.
- [5] M. Lev-On, C. LeTavec, J. Uhllein, K. Kimura, T. L. Alleman, D. R. Lawson, K. Vertin, M. Gautam, G. J. Thompson, and W. S. Wayne, N. Clark, R. Okamoto, P. Rieger, G. Yee, B. Zielinska, J. Sagebiel, S. Chatterjee, and K. Hallstrom, "Speciation of Organic Compounds from the Exhaust of Trucks and Buses: Effect of Fuel and After-treatment on Vehicle Emission Profiles," SAE paper #2002-01-2873.
- [6] F. Owrang, J. Olsson, and J. Pedersen, "Chemical analysis of exhaust emissions from a gasoline direct injection SI engine," SAE paper #2004-01-1445.
- [7] J. C. Ball, L. R. Wolf, D. M. Yost, M. E. Schulman, J. P. Wallace III, T. E. Kenney, D. L Hilden, M. Natarajan, T. V. Johnson, K. J. Wright, K. Eng, and M. A. Gonzalez D, "Emissions of toxicologically relevant compounds using dibutyl maleate and tripropylene glycol monomethyl ether diesel fuel additives to lower NOx emissions," SAE paper #2005-01-0475.
- [8] "Measurement of vapour phase organic and inorganic emissions by extractive Fourier transform infrared (FTIR) spectroscopy," EPA test method 320.
- [9] "MKS Type - MG2000 Software Manual," MKS Instruments, Wilmington.
- [10] "Standard test method for determination of gaseous compounds by extractive direct interface Fourier transform infrared (FTIR) spectroscopy," ASTM D6348-03 (2010).
- [11] "Water sensitivity tests and create water calibration procedure," MKS Instruments.
- [12] Direct communications with MKS instruments, Sylvie Bosch-Charpenay.